

Influence of Reed on Fabric Inequality in Width

Abstract

Earlier experimental investigations have demonstrated the particular regularity of inequality in warp projections in the loom-state fabric width, while the projections of wefts were constant throughout the whole width of the fabric. The changes in warp projections have a great influence upon some fabric properties. The porosity, air permeability, thickness, crimp of wefts, elongation and strength in weft of the fabric are higher in the central part of the fabric than in the border areas. The aim of this article is to investigate and analyse the influence of reed on the warp projections' inequality in fabric width. The investigations of the reed's influence on the shape of the yarns' cross-sections was carried out by imitating the weaving process on laboratory equipment. The results of these investigations demonstrated the high influence of the reed on warp projection alteration. The shrinkage of fabric increases the reed's influence on the warps' cross-section; as shrinkage (distance l) increases, so does the projection of warps increase. Herewith, the influence of the reed decreases (projections are more stable) as the stress of warps decreases; in other words, the influence of shrinkage is not so high.

Key words: warp projections, shrinkage, influence of reed.

Introduction

Earlier experimental investigations have shown the particular regularity of warp projection inequality in fabric width, while the projections of wefts are steady throughout the whole width of the fabric [1]. This structural inequality has a significant influence on some fabric properties. The porosity, air permeability, thickness, crimp of wefts, elongation and strength in weft of the fabric are higher in the central part of the fabric than in the border areas. This inequality depends on fabric shrinkage in the loom. The investigations of 20 different loom-state fabrics (various weaves, raw materials, sets, looms etc.) demonstrated the particular regularity of the fabric structure and the inequality of the properties in width and their dependence on shrinkage [4]. An example of such regular structural inequality in width is presented in Figure 1. Here we see that the images of fabric at different places in width are not the same; the warps are more flatter in the border part of the fabric (Figure 1), while in the central part of the fabric the projections of the warps in the plane of the fabric are significantly lower.

The warp threads are particularly under the influence of many factors in the looms. We wished to find out why the projections of warps, as mentioned in earlier investigations, are not stable in the fabric's width. It is well known that during the weaving process the reed blades move between ends and change the structure of the fabric (especially with rather high density structure); causing the ends' spacing in these places to increase [2]. It is also known that the weaving process changes the mechanical properties of warp and weft yarns. The changes in the mechanical properties of warp and weft after weaving depend on warp and weft density, weave, raw material composition, and the properties of fibres, yarn and fabric. Parameters affecting the changes of warp threads in the weaving process are dynamic forces caused by shed formation, the beat-up of weft, loom speed, loom type, climatic conditions, warp preparation, etc. It is known that in addition to stress in the weaving process, yarn properties change (becoming weaker) at friction points. The greatest friction ensues when the warp yarns come into contact with the dents of the reed which is moving forward and backward [3].

Therefore, we see that the reed has a very great influence on fabric properties and structure. Due to fabric shrinkage, the yarns pass the dents of the reed in different ways (the angle is different), and so they are affected differently. The reed may thus be the cause of such fabric inequality in width, as well.

The main aim of this article is to investigate and analyse the influence of the reed on warp projection inequality in fabric width.

Materials and methods

The plain-weave polyester 158 cm-width fabric manufactured from multifilament 29.4 tex yarns in warps and 27.7 tex yarns in wefts (one of twenty fabrics investigated earlier [4]) was chosen for the present investigation because it well characterises all the investigated fabrics – the inequality in width is high, but the variation of yarns projection values at experimental points is low. The presented fabric was woven on a PN 170 air-jet loom, the reed's width is 162 cm, and the shrinkage of fabric is 4 cm (2.47%).

The reed's influence on fabric inequality was investigated with yarns which are used in warp, i.e. 29.4 tex yarns. As seen in Figure 2, the fabric width in the reed L_R differs from the loom-state fabric width L . During our investigations, the fabric weaving in the loom was imitated with laboratory equipment. As seen in Figure 3, the five warp yarns were fixed in one side, and thereafter they beaded to the dents of the reed accordingly, imitating the yarn's position in the loom during weaving.

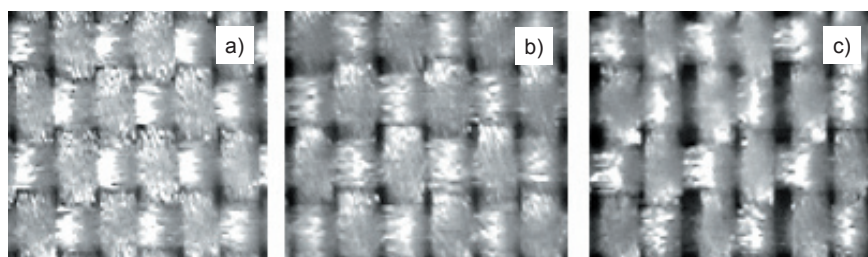

Figure 1. Image of fabric at distances of 5 cm (a), at 25 cm (b), and 70 cm (c) from its edge [1].

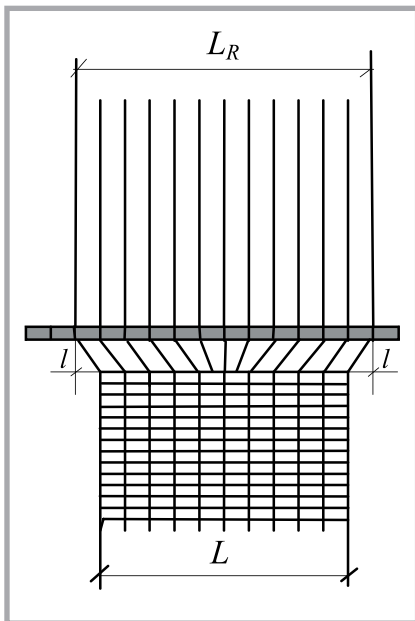

Figure 2. Fabric in the loom.

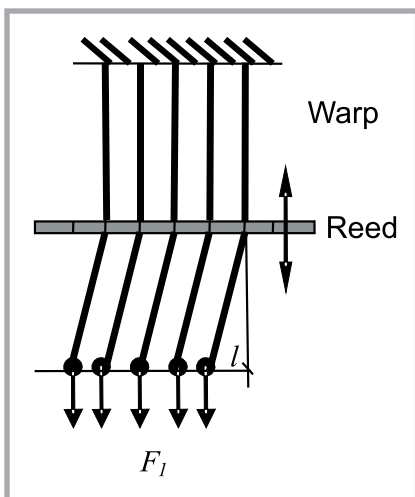

Figure 3. Imitated weaving.

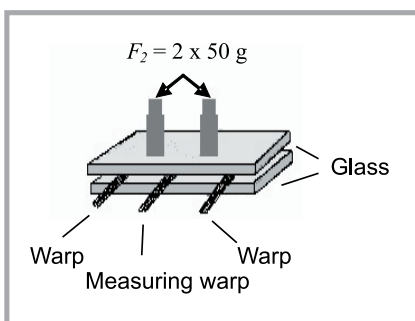

Figure 4. Warp yarn measurement under loads.

As mentioned earlier, the yarns in the reed by weaving are in a different position due to fabric shrinkage. The border yarns are thus directed to a certain distance l . This distance was calculated according to the formula:

$$l = \frac{L_R - L}{2};$$

here:

L_R – fabric width in the reed,
 L – loom-state fabric width.

According to the above-mentioned equation, the distance $l = 2$ cm is the maximum warp yarn leaning to the dent of the reed. Closer to the central part of the reed, this distance decreases; in the central part of the reed, the warp yarns pass the dents of the reed without leaning. 5 different values of distance l were chosen for experimental investigations: 2, 1.5, 1, 0.5 and 0 cm.

Herewith, the investigations were carried out when warp yarns were loaded with different loads (10 g, 35 g, 45 g, 60 g). These loads were chosen approximately to the yarn stresses in the loom from 0.3 cN/tex, 1 cN/tex, 1.5 cN/tex to 2 cN/tex. As is well known, very low stress (lower than 0.3 cN/tex) and very high stress (higher than 2 cN/tex) of the warp yarns are not usually used in the weaving process.

The distance between the cloth fell of fabric and the reed in the PN-170 loom at the back position is approximately 10.5 cm, and the set of weft yarns of presented fabric is 184 dm⁻¹. Therefore, the process of moving the reed in the laboratory equipment forward to backward, which imitates a weaving cycle, was repeated 200 times.

The measurements of yarn projections were carried out using a PC and an Askania microscope (the accuracy of measurements is ± 0.001 mm). The projections of the affected as well as the unaffected warp yarn under different loads were measured.

As seen in Figure 4, the three polyester warp yarns were loaded with glass (2.5×7.6 cm, the weight is 6.517 g) and with 2 50 g loads. The central yarn was used for measuring the projections. 100 warp projection measurements of yarn were carried out at each experimental point.

Experimental results and discussions

The preliminary investigations showed a great difference between the measured warp yarn projections under different loads and different positions in the reed. As mentioned above, the warp yarns in the weaving process imitation on the laboratory equipment were loaded with a certain load F_1 . At the first stage of the investigations, the load F_1 was set very low, at 10 g (the yarns' stress is 0.3 cN/tex). As seen in Figures 5.a, b and c, the images of warp yarns with different leaning (distance l is 0 cm, 1 cm, and 2 cm) are different; the projections increase when the distance l increases, but the difference is not higher than 25%.

When the warp yarns were loaded with higher loads, the influence of the yarn's position in the reed increases very sig-

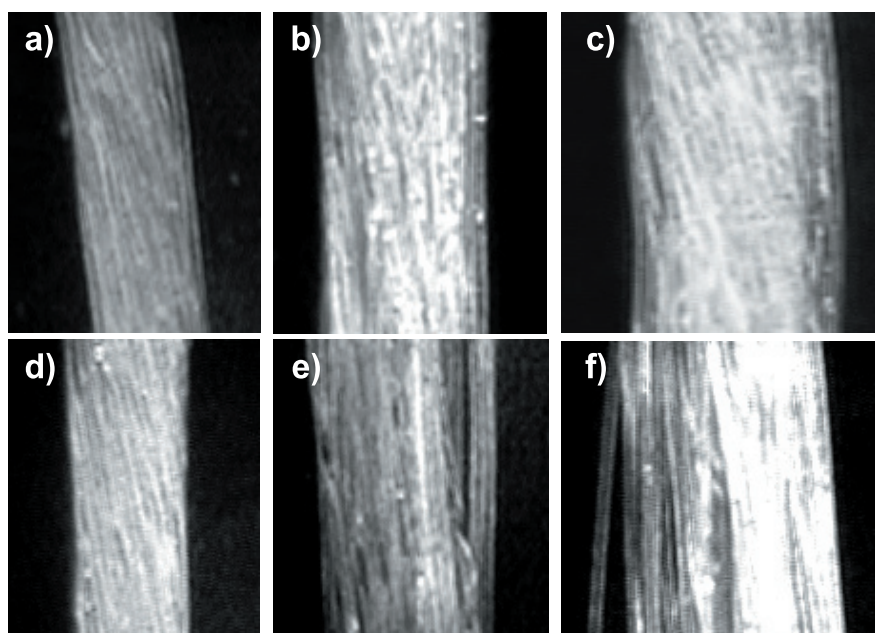

Figure 5. Warp projections under 10 g load: a) $l=0$ cm, b) $l=1$ cm, c) $l=2$ cm and warp projections under 60 g load: d) $l=0$ cm, e) $l=1$ cm, f) $l=2$ cm.

nificantly. As seen in Figures 5.d, e and f, the images of warp yarns show that the effect of the reed is greater when the load of yarn and the yarn position in the reed (distance l) are higher. When the load of warp yarn F_1 is 60 g and distance $l = 2$ cm, the difference of yarn projections is even as much as 65%.

So, the projections of yarns depend both on leaning (distance l) and the yarn stress (load F_1). On this basis, the experimental investigations were carried out with the focus on these two factors, which influence the yarn's cross-section shape. The dependences of warp projections on leaning (distance l) with various yarn stresses (load F_1) are presented in Figure 6.

This figure shows that the dependences of warp projections on distance l (see Figure 2) are not the same. During weaving in the loom, the warp yarns pass the dents of the reed in different ways, due to fabric shrinkage, that is, with different

leanings. In the border parts of fabric they pass the reed with maximum leaning ($l = 2$ cm) and in the centre of the fabric the warp yarns pass the dents of reed without any leaning ($l = 0$ cm). When the warp yarn is under very low stress (0.3 cN/tex), the character of the curve differs significantly from the others. When warp yarn stress increases, the character of curves changes; the influence of leaning increases in all cases when stressing increases, as well. The initial point (l at 0 cm) of all curves was chosen as the average value because the variation of the results falls within the error limits, and the experiment is non-informative. The coefficient of variation of all the experimental points was not higher than 10%.

As seen in Figure 6, the dependence of warp projections on the distance l in real fabric has the same tendency as do the yarns after weaving imitation (the projections increase when the leaning increases),

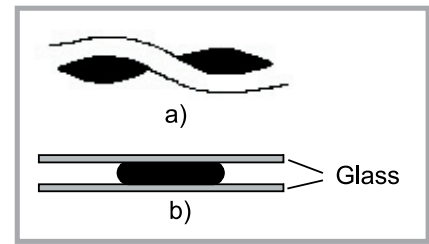

Figure 7. Warp yarns' cross-sections a) in real fabric, b) under loading with glass.

but the values of projections are not the same. The stress of the warp yarns in fabric is approximately 1 cN/tex, but the curve of the warp yarn projections' dependence on leaning in the real fabric is not close to the curve of yarn projections after the weaving imitation under a yarn load of 35 g (the stress is 1.2 cN/tex). The shape of the cross-section of yarns after loading with glass and additional loads F_2 is significantly different from the shape of the warp's cross-section in real fabric. After being loaded with glass, the shape of cross-section becomes like that of a race track, while in the real fabric it has the shape of a lens or a semi-lens (see Figure 7) [5, 6].

The cross-section of warp yarns in the fabric (as seen in Figure 7) is obtained when the opposite system of yarns (wefts) squeeze the warps with a certain force but to measure the considered values are difficult. Herewith the shape of wefts is also a lens. It is therefore very difficult to imitate such a sophisticated effect on warps. In our measurements, the warp yarn is loaded with the glass, so with two planes. It is impossible to compare the concrete values of yarn projections of such different shapes, although the tendency of dependences is the same; the projections of yarns increase as the leaning increases. Therefore it is possible to assert that the reason for the inequality of the yarn projections in fabric width is the reed.

In Figure 8 the dependences of warps projections on the loading F_1 are presented. As seen in Figure 8, all the dependences can be described as linear. The coefficients of determination of the presented straight lines when the yarns passed the reed with leaning (distance $l \neq 0$) are very high ($R^2 = 0.8724 \div 0.9993$), and only when the distance l is 0 cm does the coefficient of determination reach very low levels ($R^2 = 0.1132$), which means that when warp projections pass the reed dents without leaning, they are almost identical.

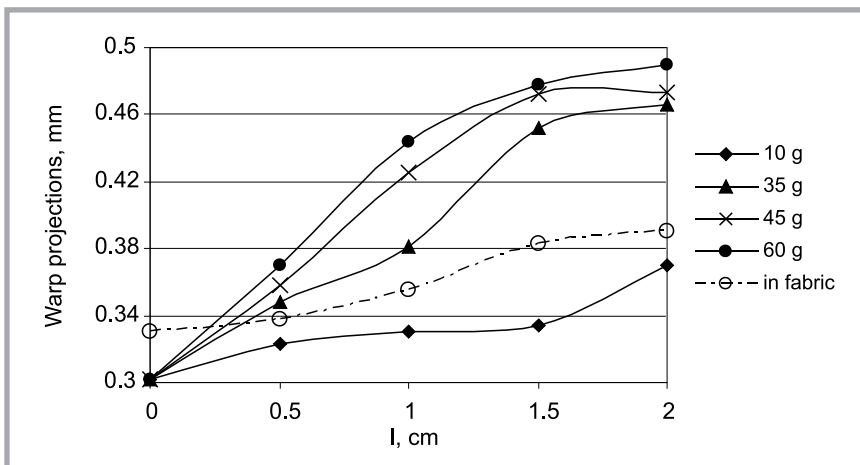

Figure 6. The dependences of warp projections on distance l with different loads F_1 .

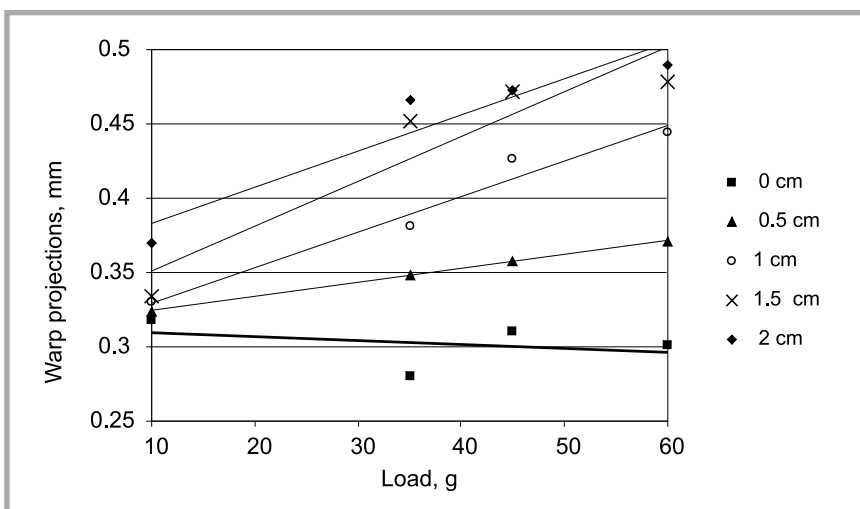

Figure 8. The dependences of warp projections on load F_1 with different distances l .

We can thus assert that the increase in yarn stress in the loom increases the fabric inequality in width (the effect of reed on the warps is higher), and for the fabric inequality in width decreasing, it is necessary to use a low yarn stress in the loom.

Conclusions

- The experimental investigation with the imitation of the weaving process showed that the reason for fabric inequality in width is the reed, and more precisely the warp yarn's friction on the dents of the reed in the loom.
- The level of fabric inequality in the width depends on the yarns' leaning when they pass the reed; if the shrinkage (distance l) increases, the inequality of warp projections increases as well.
- The warp stress in the loom also influence the level of fabric inequality. When yarn stress increases, the effect of reed on the warps increases as well.
- For fabrics with high shrinkage, in order to decrease the fabric's inequality in width, it is necessary to use a low yarn stresses in the loom.



References

1. Milašius, R., Rukuižienė, Ž. 'Fabric Inequality in Width', *Proceedings of 4th World Textile Autex Conference, 2004, Roubaix, France*, pp. 866-871.
2. Masajtis, J., Owczarek, M. 'Modelling of Woven Fabric's Structure by Weaving Conditions', *Proceedings of 5th World Textile Autex Conference, 2005, Portorož, Slovenia*, pp. 866-871.
3. Kovačević, S., Wadsworth, L., Ujević, D., Vitez, D., 'The Changes of Physical-Mechanical Properties of Yarn in Weaving', *Proceedings of 2nd International Textile Clothing & Design Conference, 2004, Dubrovnik*, pp. 216-221.
4. Milašius, R., Rukuižienė, Ž. 'Investigation of Correlation of Fabric Inequality in Width with Fabric Shrinkage', *Fibres & Textiles in Eastern Europe*, #3, 2003: pp. 41-45.
5. Matsudaira M., Tan Y., Kondo Y., 'The Effect of Fibre Cross-Sectional Shape on Fabric Mechanical Properties and Handle', *The Journal of The Textile Institute*, Vol. 84, No. 3, 1993, pp. 376-386.
6. Masajtis J., 'Construction and Design of Fabrics', *Technical University of Lodz, 1991 (in Polish)*.

Received 15.12.2005 Reviewed 13.06.2006

The Institute of Biopolymers and Chemical Fibres

awarded the 'Croix de Chevalier' of the Invention Order
of the Kingdom of Belgium

during the 55th Brussels Eureka 2006

World Exhibition of Invention, Research and Industrial Innovation
for the entire innovative activity presented at Brussels.

The following invention was also awarded the silver medal:

PARTIALLY RESORBABLE HERNIA MESHES

Authors: Antoni Niekraszewicz, Marcin H. Struszczyk*, Magdalena Kucharska, Bogdan Gruchała and Kinga Brzoza-Malczewska

Institute of Biopolymers and Chemical Fibres, Łódź, Poland

***TRICOMED S.A, Łódź, Poland**

Hernias are a most important social problem which statistically occurs in 2% of the population. The number of hernioplasties carried out in Poland is around 40,000 annually. 50% of the above-mentioned cases are treated with hernia meshes made of synthetic material. In the USA, about 75% of hernioplasties are carried out using a tension-free method using hernia meshes. The tension-free method is especially effective in the case of large ring hernias and recurrence hernias. The best known disadvantage of using synthetic, non-absorbable mesh is the discomfort of patients which arises in the long term after implantation. This complication is connected with the formation of a thick, stiff scar around the implant, affecting the blood supply in the mesh surrounding the organs, and which increases the risk of the mesh adhering to the viscera and the consequent formation of fistula.

The aim of the study was to devise a technology of innovative, partially resorbable hernia meshes. The effect of the research was the development of two versions of the mesh:

1st version: two types of yarns – the resorbable multifilament yarn made of chitosan and the non-absorbable biocompatible monofilament yarn made of polypropylene were applied to knit meshes using a Rachel knitting machine with the ratio of chitosan yarn ranging from 12 wt% to 50 wt%.

2nd version: a microporous resorbable layer of chitosan was formed on the surface of the semi-finished product of the non-absorbable Optomesh™ MacroPore hernia mesh (produced by Tricomed SA). A new form of chitosan was applied for the formation of the resorbable layer. A single layer on the external surface or a bi-layer on both the external and internal surfaces of the hernia mesh was applied.

The mechanical behaviour, chemical purity and biological properties of the modified-EO sterilised hernia meshes were evaluated. The maximum breaking force and elongation at break (according to PN-EN ISO 13934-1:2002 standard), the bursting strength (according to PN-EN ISO 12236:1998 standard) and the mesh stiffness (according to PN-73/P-04631 standard) were determined for characterisation of the modified hernia meshes' properties.

Partially resorbable meshes applied to the tension-free treatment of hernias should be helpful in reducing the risk of adhesion and fistula formation and the consequent reduction of hospitalisation costs.

- The research was carried out in cooperation with Tricomed SA/Poland.
- Polish Patent Application PL 380861 "Composite surgical net and method for manufacturing the composite surgical net"
- The work was supported by the Ministry of Science & Higher Education, project No. 3 T08E 03727.

For more information please contact:

Institute of Biopolymers and Chemical Fibres
M. Skłodowskiej-Curie 19/27,
90-570 Łódź, Poland

TRICOMED S.A
Piotrkowska 270,
90-361 Łódź, Poland