

# Assessment of the Simultaneous Influence of Yarn Linear Mass and the Real/Service Loading Cycle on the Fatigue Life of Smooth and Flame Cotton Yarns

DOI: 10.5604/01.3001.0013.7309

University of Bielsko-Biala,  
Faculty of Mechanical Engineering  
and Computer Science,  
Bielsko-Biala, Poland,  
<sup>\*</sup>e-mail: rdrobina@ath.bielsko.pl  
<sup>\*\*</sup>e-mail: jacek@ath.bielsko.pl

## Abstract

*In the paper, the results of fatigue investigations on smooth and flame yarns are presented. The investigations were performed for yarns of the following types 25, 30, 40 and 50 tex, i.e. for thin yarns as well as for relatively thick ones made in spinning mills. An assessment of fatigue life was made based upon statistically analysed Wöhler curves. Aiming for a more complex presentation of changes over time taking place due to variable loading, we performed an assessment of the simultaneous influence of linear mass changes for smooth and flame cotton yarns as well as coefficients of the real loading cycle on the fatigue life of adequate yarns (represented by the number of loading/fatigue cycles). A statistical approach to the identification of characteristics of fatigue life was utilised. Experimental data were approximated via linear-square polynomials. Additionally, factor analysis was performed, which has not been considered till now, in relation to the fatigue phenomena modelling. Due to the wide and comprehensive plan of experiments as well as the number of trials and specimens utilised, such investigations are rarely described in references. Within the framework of the experiment program, a consecutive series of planned tests: 4 x 8 based upon 32 variants for 20 tests were taken into consideration for smooth yarns of every variant as well as an adequate number of tests performed separately for cotton flame yarns. This allowed us to make versatile statistical analyses and reliable identification of needed quantities and parameters. Utilisation of a pre-designed (planned) experiment allows for assessment of the average behaviour of a product in a real technological process, while methods considering characteristics in dependence on one variable are too simple for showing the ongoing changes. They could not fully represent the behaviour of an artifact/product in service conditions.*

**Key words:** cotton yarn, Wöhler's chart, statistical identification, multiple regression.

## Nomenclature

$B$  – coefficient of regression function,  $F$  – statistics  $F$  – Snedecor,  $M_p$  – initial elasticity module of yarn,  $n$  – number of experiments performed within laboratory investigations,  $N$  – fatigue life,  $R$  – coefficient of multi correlation,  $R_e$  – plasticity limit,  $Tt$  – linear mass of yarn,  $W_t$  – specific average strength of yarn,  $X$  – matrix of experiments,  $Y$  – vector of outputs of the object.

## Nomenclature – Greek signs:

$\alpha$  – significance level,  $\beta_p$  – coefficient of fatigue life,  $\eta_s$  – coefficient of static strength,  $\sigma_a$  – amplitude of loading cycle,  $\sigma_{max}$  – maximal loading of a cycle,  $\sigma_{min}$  – minimal loading of a cycle,  $\sigma_m$  – average loading of a cycle,  $\sigma_s$  – coefficient of the real loading cycle.

## Introduction

The application of high quality components in clothing production allows to obtain excellent products i.e. having pre-defined parameters such as: elasticity and low contractility, as well as to prevent against colour fading during washing. Another solution could be implemented i.e. the modification of utilised production technology which allows to obtain a product with a prescribed fatigue life or strength.

In the production of clothing dedicated for general usage as well as for special clothing, different types of yarns are commonly used. In general, we consider a yarn as a textile product of continuous, cylindrical structure, which is made as a result of the twisting of fibre bands during a process called spinning. It is made of long and short fibres e.g. of cotton [2, 13, 15].

The number of twists which occur in a 1 m length of yarn is a crucial factor determining its breaking strength softness. A low number of twists causes that the yarn is slightly rough, but stronger.

Sometimes, several yarns are twisted mutually, which causes that the yarn obtained has higher breaking strength and resistance against wear as well as that we can obtain a yarn of higher smoothness [2, 13, 15]. The manufacturing of yarn is highly complicated because the defects which can occur are sources of possible breakages. Moreover, one of the most frequently observed causes of textile material damage is a fatigue failure, which is dangerous in its consequences due to its unexpected nature. Textile materials are usually subject to damage due to the loadings being essentially lower than those determined during static tests. Damage occurs without any visible plastic deformations, despite the causes of damage being – among others – imperfect material elasticity [2, 13, 15].

The aim of the present paper was the assessment of the results of the simultaneous influence of the variability of the linear masses of cotton yarns and the coefficient of the real loading cycle on the fatigue life of yarns. Fatigue life is measured via the number of fatigue cycles. Aiming to establish the variability of ongoing phenomena, we applied the statisti-

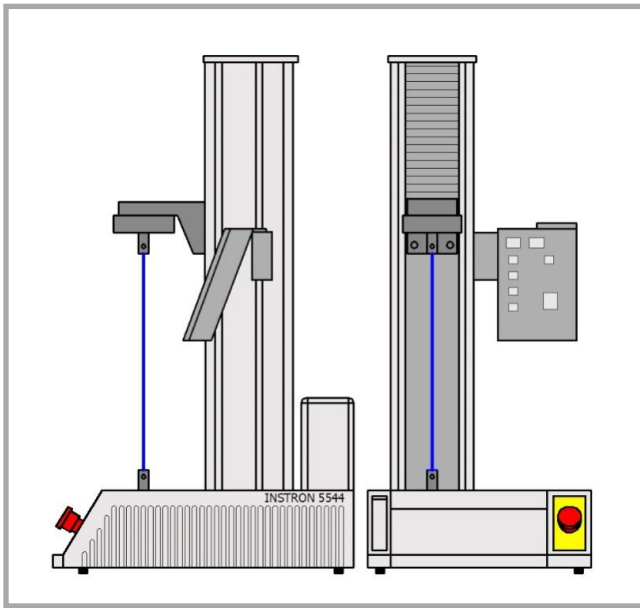

Figure 1. Tensile tester Instron 5544 with a specimen mounted.

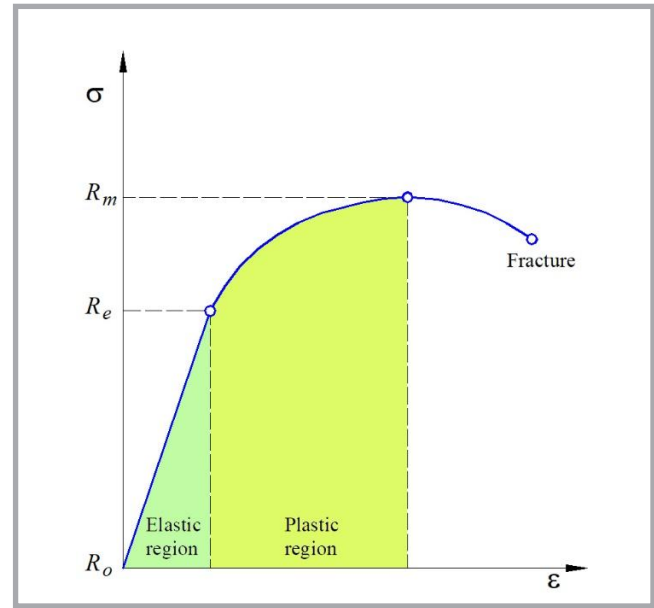

Figure 2. Scheme of tensile curve, with characteristic points marked.

cal method of identification. The data sets obtained were approximated by means of linear-square polynomials. The paper is based upon previous experiments, practical knowledge as well as the experience of the authors in the field of evaluation of the fatigue life of linear textile products. Due to the common usage of composite materials in industry, in particular in the automotive sector, the problems discussed could be adapted for evaluation of materials applied on carcasses depending on the twists/weave/plait.

## ■ Experimental investigations

The investigations of fatigue life were performed by means of a tensile tester (tensile testing machine, tensile strength tester) – INSTRON model 5544, equipped with Merlin and Test Profiler software (Figure 1) [2, 3].

As the minimal value of the loading cycle  $\sigma_{\min}$ , we assumed the average value of the module of the initial elasticity of smooth yarns  $\bar{M}p_n$  and flame yarns  $\bar{M}p_p$  (cN/tex), respectively [3]:

$$\begin{aligned} \sigma_{\min} &= \bar{M}p_n = \text{const}; \\ \sigma_{\min} &= \bar{M}p_p = \text{const} \end{aligned} \quad (1)$$

determined upon 50 measurements performed for each of the smooth cotton yarns  $T_m = [25 \ 30 \ 40 \ 50]^T$  (tex) as well as flame yarns [3].

The module of initial elasticity was determined in a graphical manner based upon the straight interval  $R_0 - R_e$  of the

tensile chart (curve) [3] according to Hooke's law, whereas point  $R_e$  was identified based on the conventional yield point (Figure 2).

Within the interval  $R_0 - R_e$ , theoretically, Hooke's law holds, which means that the existing elongations are elastic, (so called: immediate), in the restricted range – elastic-retarded elongations can also occur. Taking into account the traditional notation applied in the textile field of knowledge in what follows, the linear elastic limit  $R_e$  is defined (named) as the module of initial elasticity  $Mp$  (cN/tex).

The maximal loading  $\sigma_{\max}$  was established upon data related to determination of the average loading causing breakage of the yarn tested  $\bar{W}_t$  (cN/tex) based upon 50 measurements made for each of the yarns considered i.e. smooth yarns  $T_m = [25 \ 30 \ 40 \ 50]^T$  and flame yarns  $T_p = [25 \ 30 \ 40 \ 50]^T$  (see [2, 3]). Due to the test material discussed, i.e. smooth and flame cotton yarns (with the so-called flame effect), for characterisation of the maximal loading, we introduce the coefficient of the real loading cycle  $\sigma_s$ . This coefficient depends on the level of loadings in a particular cycle. It was assumed that the fatigue life will be determined for eight levels of loadings [4]:

$$\begin{aligned} \sigma_s = & \left[ 0,98 \cdot \bar{W}_t \quad 0,95 \cdot \bar{W}_t \quad 0,85 \cdot \bar{W}_t \right. \\ & 0,75 \cdot \bar{W}_t \quad 0,65 \cdot \bar{W}_t \quad 0,55 \cdot \bar{W}_t \\ & \left. 0,50 \cdot \bar{W}_t \quad 0,40 \cdot \bar{W}_t \right]^T \end{aligned} \quad (2)$$

An assumption of the maximal upper value of the loading cycle  $\sigma_{\max} = \sigma_s = 0,98 \cdot \bar{W}_t$  (cN/tex) was made, considering that in the case of fatigue investigations and loadings  $\sigma_{\max} > 0,99 \cdot \bar{W}_t$  (cN/tex) and that over 99% specimens of yarns were subject to damage in a number of fatigue cycles  $N_p \leq 1$  and  $N_n \leq 1$ . Therefore, this range was essentially near to that of loads causing damage to a yarn [2, 3].

Moreover, an assumption of the maximal lower value of the loading cycle  $\sigma_{\max} = \sigma_s = 0,40 \cdot \bar{W}_t$  (cN/tex) was influenced by the fact that the fatigue strength was close to the range of the ultimate fatigue strength, considered as the fatigue limit of a particular material. In fact, the idea mentioned last means that the material could be in service for an infinitely long time in the case of periodically-changing loadings [3].

To obtain a description of changes in the strength of flame yarns in comparison to smooth yarns within the range of similar linear masses, we introduce the coefficient of fatigue life:

$$\beta_p = \left( 1 - \frac{N_n}{N_p} \right) \cdot 100\% \quad (3)$$

For the determination of Wöhler charts for the yarns analysed in conditions of particular loading cycles and for assessment of the results of the influence of fatigue cycles on the value of the coefficient of real loading of the yarns analysed, we applied the non-linear regression model. The data obtained were

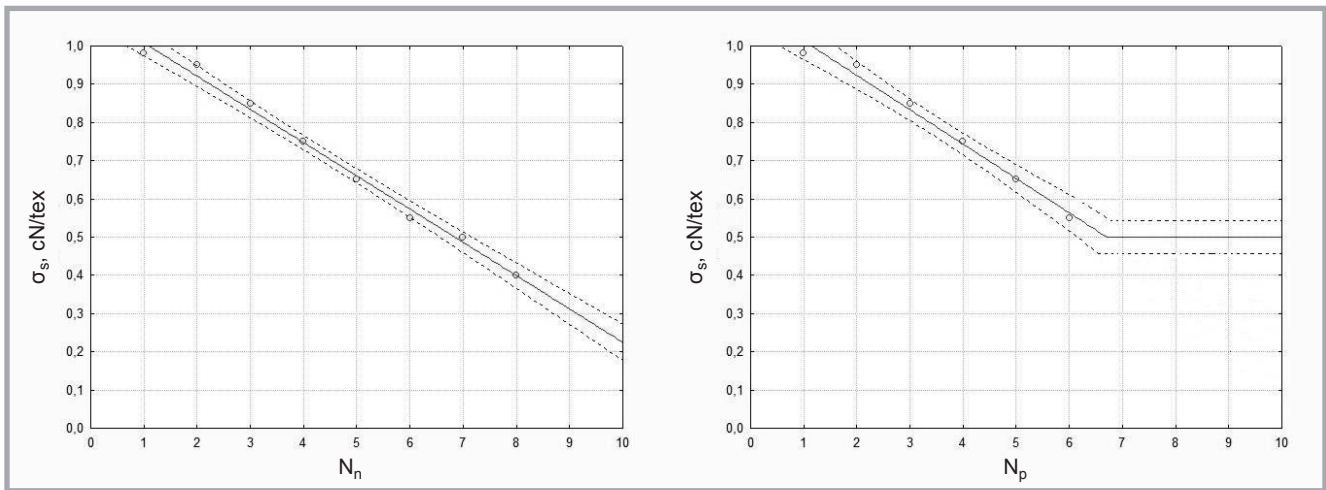

Figure 3. Statistical description of charts of fatigue life for smooth cotton yarns  $N_n$  and flame yarns  $N_p$  of 25 tex linear mass.

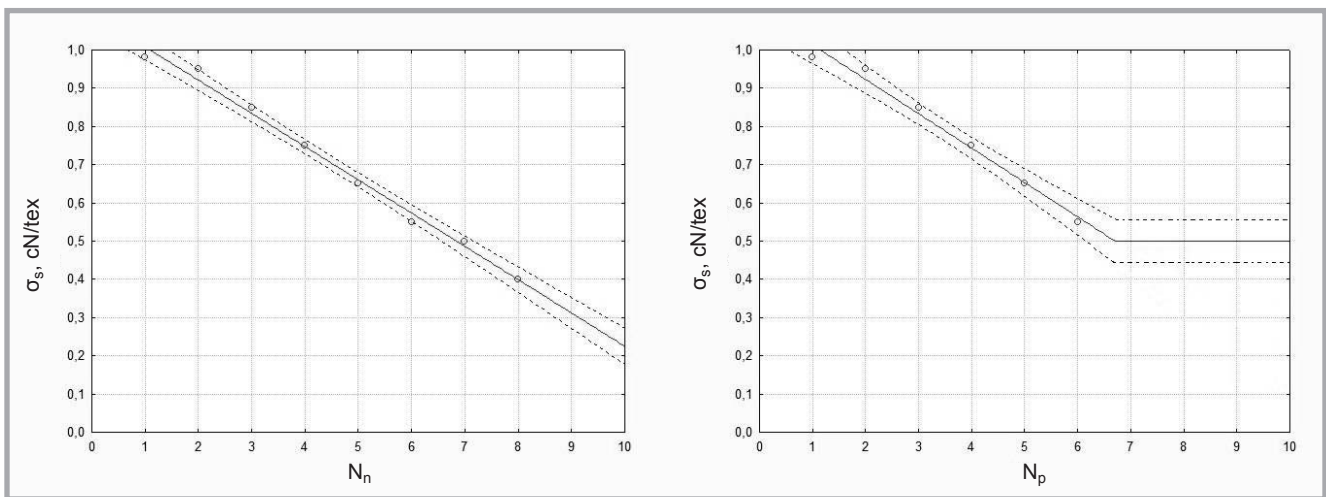

Figure 4. Statistical description of charts of the fatigue life for smooth cotton yarns and flame yarns of 30 tex linear mass [3].

approximated by means of functions in logarithmic coordinate systems. Analyses of these problems have already been performed e.g. in [3, 4].

Compatibility of the output from the model with that from the object was evaluated based upon the coefficient of multi correlation  $R$ , expressed by means of the following formula:

$$R = \frac{\sqrt{\sum_{i=1}^n (\hat{\sigma}_{si} - \bar{\sigma}_s)^2}}{\sqrt{\sum_{i=1}^n (\sigma_{si} - \bar{\sigma}_s)^2}} \quad (4)$$

where:

- $\sigma_{si}$  – output of the object in  $i$ -th experiment,
- $\hat{\sigma}_{si}$  – output of model  $u$  in  $i$ -th experiment,
- $n$  – number of tests during the experiments,
- $\bar{\sigma}_s$  – average value of the object output and model output.

Whereas the significance of the regression function determined was checked based on the statistical relationship between the statistics  $F$  and the coefficient of multi correlation 'R' [3]:

$$F_{0,05}(k, n-k-1) = \frac{n-k-1}{k} \cdot \frac{R^2}{1-R^2} \quad (5)$$

For obtainment of a regression equation, useful in controlling the manufacturing process of cotton yarns (smooth and flame types) and simultaneously ensuring an adequate significance level (assumption  $\alpha = 0.05$ ), the following output condition should be fulfilled [3]:

$$F_{obl} = F_{0,05}(k, n-k-1) \geq F_{kr} \quad (6)$$

where:

- $F_{kr}$  – critical value of statistics  $F$  – Snedecor determined upon the statistical tables of the Fisher-Snedecor distribution, for significance level  $\alpha = 0.05$ , and in the case of the freedom number  $k$  and  $n-k-1$ .

Wöhler charts were prepared for the yarns investigated in terms of the same average loading  $\sigma_m = const$ . Graphical images of the theoretical relationships were prepared according to the methodology described in [2, 3, 4, 11].

In **Figures 3-6**, charts of the fatigue life of smooth and flame cotton yarns are presented. These charts were created taking into account the confidence intervals at the level  $(1 - \alpha) = 0.95$ , for the average fatigue life  $\bar{N}_n$  and  $\bar{N}_p$ , respectively (cycles).

The regression equation determined for 25 tex smooth yarn was described by the relationship:  $\hat{\sigma}_{sn} = 1.152 - 0.099 \cdot N_n$  in the logarithmic co-ordinate system. The multi-correlation coefficient was equal to  $R = 0.998$ ; F-Snedecor statistics  $F_{obl} = F_6^1 = 1771.90 > F_{kr} = 5.99$ , whereas the confidence interval was  $2.706 < N_n < 6.287$ . Then, a regression

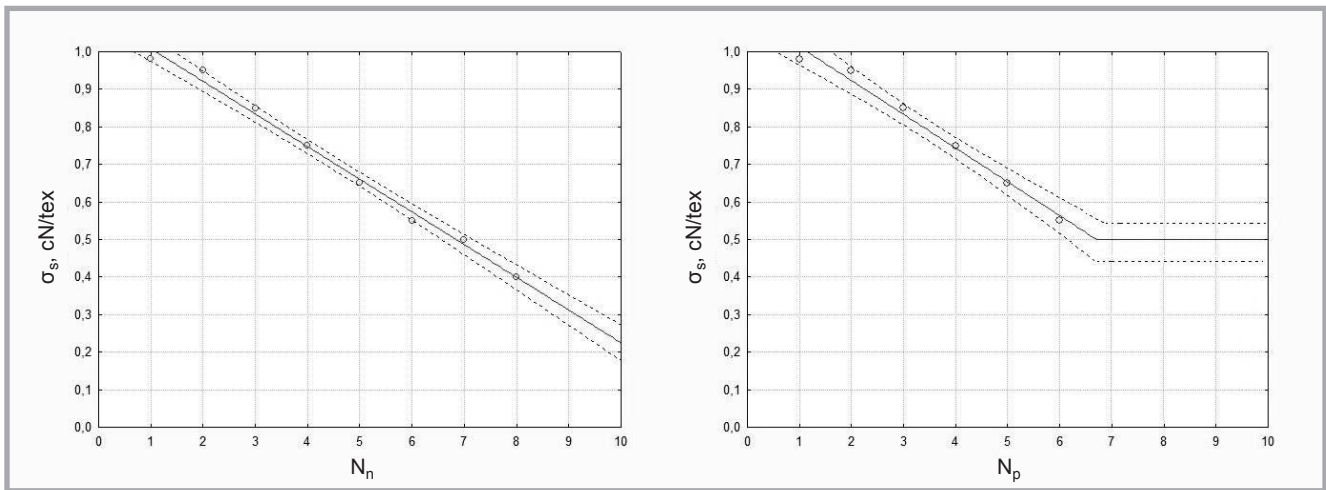

Figure 5. Statistical description of charts of the fatigue life for smooth cotton yarns and flame yarns of 40 tex linear mass [3].

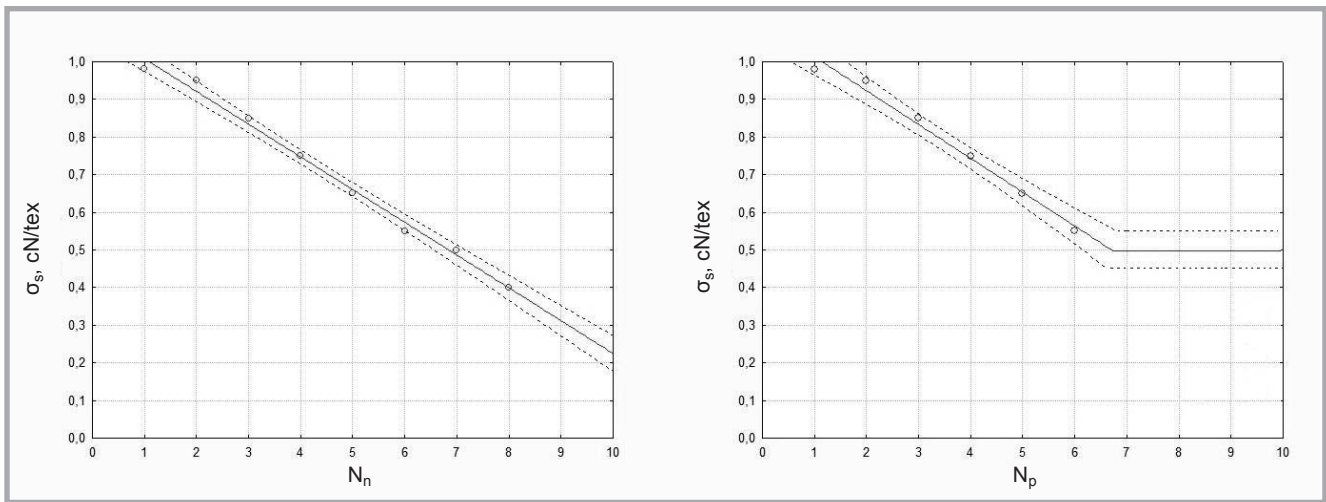

Figure 6. Statistical description of charts of the fatigue life for smooth cotton yarns and flame yarns of 50 tex linear mass.

equation was determined for 25 tex flame yarn using the given formula:  $\hat{\sigma}_{sn} = 1.069 - 0.048 \cdot N_p$ . The coefficient of multi-correlation was equal to  $R = 0.998$ ; F-Snedecor statistics  $F_{obl} = F_4^1 = 270.11 > F_{kr} = 7.71$ , whereas the confidence interval was as follows:  $2.161 < N_p < 9.466$ .

Analysing the data shown in **Figure 1**, we can observe differences in the values of the fatigue life of smooth and flame cotton yarns. The fatigue life chart is approximated by a straight line  $\alpha$ , and the points shown in the chart are situated within the borders of the confidence interval  $(1 - \alpha) = 0.95$ . It confirms the correctness of the choice of levels of the coefficient of the real loading cycle within the fatigue life range i.e. at eight loading levels, considering twenty positive tests at each level in each case (2).

However, in the case of flame cotton yarns, fatigue life was determined at six

levels, due to the achievement of infinite fatigue strength  $N_{nieogr} \rightarrow +\infty$  just at the level  $\sigma_s = 0.50 \cdot \bar{W}_t$  (cN/tex). The linear equation presented describes correctly the fatigue life of smooth and flame cotton yarns.

The functions proposed, derived upon statistical analysis, could be effectively utilised in the method of assessment of the fatigue life of smooth and flame cotton yarns elaborated. For the remaining yarns, the relationships observed also have a linear nature, which is presented in **Figures 4-6**.

The regression equation determined for 30 tex smooth yarn was described (in the logarithmic co-ordinate system) by means of the following function:  $\hat{\sigma}_{sn} = 1.181 - 0.105 \cdot N_n$ . The coefficient of multi-correlation was equal to  $R = 0.991$ ; F-Snedecor statistics  $F_{obl} = F_6^1 = 336.75 > F_{kr} = 5.99$ ,

whereas the confidence interval was:  $2.855 < N_n < 6.226$ .

Moreover, the regression equation determined for 30 tex flame yarn has the form:  $\hat{\sigma}_{sp} = 1.115 - 0.050 \cdot N_p$ . The coefficient of multi-correlation was equal to  $R = 0.986$ ; F-Snedecor statistics  $F_{obl} = F_4^1 = 148.09 > F_{kr} = 7.71$ , whereas the confidence interval was:  $3.038 < N_p < 10.08$  [3].

The regression equation determined for 40 tex smooth yarn (in the logarithmic co-ordinate system) has the following form:  $\hat{\sigma}_{sn} = 1.252 - 0.114 \cdot N_n$ . The coefficient of multi-correlation was equal to  $R = 0.983$ ; F-Snedecor statistics  $F_{obl} = F_6^1 = 175.85 > F_{kr} = 5.99$ , whereas the confidence interval was:  $3.259 < N_n < 6.340$ . The regression equation determined for 40 tex flame yarn has the following form:  $\hat{\sigma}_{sp} = 1.116 - 0.048 \cdot N_p$ . The coefficient of multi-correlation



was equal to  $R = 0.985$ ; F-Snedecor statistics  $F_{obl} = F_4^1 = 138.40 > F_{kr} = 7.71$ , whereas the confidence interval was:  $3.155 < N_p < 10.40$  [3].

The regression equation determined for 50 tex smooth yarn (in the logarithmic co-ordinate system) has the following form:  $\hat{\sigma}_{sn} = 1.179 - 0.099 \cdot N_n$ . The coefficient of – multi correlation was equal to  $R = 0.995$ ; F-Snedecor statistics  $F_{obl} = F_6^1 = 614.17 > F_{kr} = 5.99$ , whereas the confidence interval was:  $2.989 < N_n < 6.561$ . The regression equation determined for 50 tex flame yarn has the following form:  $\hat{\sigma}_{sp} = 1.102 - 0.046 \cdot N_p$ . The coefficient of multi-correlation was equal to  $R = 0.978$ , F-Snedecor statistics  $F_{obl} = F_4^1 = 90.421 > F_{kr} = 7.71$ , whereas the confidence interval was:  $2.981 < N_p < 10.42$ .

In the Wöhler curves presented, we can observe damage to yarns within the low-cycle region *I* in the case of applying tensile variable loading (one side positive) [3], where tensile has a character of static plastic damage (breakage). Theoretically, damage to such material occurs by ultimate plastic deformation, comparable to that caused by static loading. In the case of all yarns analysed, the fatigue life of flame cotton yarns is higher than for the others, which is caused by the higher number of twists. However, in comparison to the assessment of static strength, the opposite is the case, and the process of material damage – typical for static loading – in other cases is essentially different. The coefficient of static strength for flame yarns is equal to  $\eta_{s_{25\text{tex}}} = 93\%$ , which means that flame yarns of 25 tex linear mass reach 93% of the static strength for smooth yarn of similar linear mass. However, it is caused by the utilisation of different measurement conditions for the yarns investigated [1, 4, 8, 9, 10]. The direct influence on the results obtained was an absolute increase in the specimen length equal to 150 mm/min during the performance of static strength investigations. In the case of evaluation of the fatigue life, the absolute increase in elongation was essentially higher, i.e. the elongation value was approximately above 1000 mm/min depending on the constant (for all yarns analysed) set frequency of stress variability  $f_c = 4$  Hz. In the case of yarns of 30 tex and 40 tex linear mass, the coefficient of static strength for flame yarns was equal to  $\eta_{s_{30\text{tex}}} = 91.63\%$  and  $\eta_{s_{45\text{tex}}} = 95.95\%$ ,

respectively. Essential diminishing of the static strength was characteristic for yarn of 50 tex linear mass, whereas the coefficient of static strength was equal to  $\eta_{s_{50\text{tex}}} = 72.44\%$ . It was caused by the fact that yarn of such linear mass – made by the thin-yarn system – could be within the spinning range of linear masses despite making sure of proper technological routines.

The fatigue life of smooth and flame cotton yarns was influenced by the variable loading acting on the yarn, causing its damage. Fatigue strength differs essentially from typical static strength with respect to constant static elongation. The characteristic feature of the process of material damage during the fatigue investigations is that the phenomenon passes without visible (on a macroscopic scale) plastic deformations on the surface of the product. Moreover, the fatigue strength in the initial phase is connected with perpendicular features in relation to the maximal elongation. Within the process of the initiation and arising (development) of the fatigue damage of yarn, a region/volume can be observed in which a particular change inside the yarn occurs, consisting in the phenomenon of yarn migration [5, 6, 15]. Within the range of low and high cycles, one can observe the phenomenon of counter-spinning and splitting of streams of yarn, which together accompany the damage to the yarn.

To obtain a comprehensive model of the fatigue life of smooth and flame cotton yarns, we decided to perform an assessment of the simultaneous influence of changes in the linear mass and real loading cycle.

### Usefulness of statistical factor analysis for identification of the fatigue life of smooth and flame cotton yarns

In most cases, statistical properties of linear textile products imply the necessity of utilisation of statistical identification methods. The method of factor analysis has versatile applications e.g. for an assessment of technological processes as well quantitative properties of a stream of yarns. It provides an image of the average behaviour of a product within its current technological process. On the contrary, the methods for characteristics via the one-variable-function are related to the situation where too simplified

assumptions are made; therefore, such models do not allow for a complete grasp of the ongoing changes.

As was mentioned above, linear textile products are frequently subjected to time-varying loading, which causes that fatigue phenomena occur. These loadings usually have a very complex nature. Especially, in the case of textile products, we can consider the average loading caused by their own weight or initial loading connected with consecutive phases of the technological process. The existing asymmetry of loading has a direct influence on the amplitude of fatigue loading [8]. Moreover, recognition of the mutual relationships between the maximal variable loading and the linear mass of yarns is essential in relation to the assessment of the fatigue life of smooth and flame cotton yarns. Making some assumptions, it is possible to utilise the statistical models for calculations within the range of fatigue life for quasi-static loadings and low-cycles conditions for smooth yarns. In the case of flame cotton yarns, this range can be widened in the area of high-cycle loadings. As is stated in references [8], there are no essential differences between quasi-static and low-cycle strength, or between low-cycle and high-cycle behaviour. In every case, there are intervals of stop-wise transformation between particular types of damage. Therefore, the roughly considered ranges of loading cycles should be differentiated and specified depending on the type of material and loading conditions. In the case of materials investigated [2, 4], till now, fatigue life assessment has not been performed in such a manner that full statistical analyses of Wöhler curves are incorporated. The approach to the formulated problem proposed constitutes a new attitude to tasks related to the assessment of the fatigue life of linear textile products. Frequently, in engineering practice [8], the average loading is considered, as well as the relationship between the amplitude of the loading cycle  $\sigma_a$  and the average loading of a particular cycle  $\sigma_m$ . There are some special reasons for the assessment of fatigue life at the level of the fatigue limit. In references, it was shown that the commonly utilised linear or parabolic relationships can be applied for a narrow range of the average loadings [2, 3, 4, 7].

Due to the special materials investigated, we propose an assessment of the simultaneous influence of the coefficient of the

real loading cycle for all linear masses (for smooth yarns) on the fatigue life, as well as a separate analysis of the influence of these changes on the fatigue life of flame cotton yarns.

For assessment of the simultaneous influence of changes in the linear mass of the cotton yarns (smooth and flame types)  $T_m$  and  $T_p$ , respectively, and the coefficients of the real loading cycles  $\sigma_{sn}$  and  $\sigma_{sp}$ , on the fatigue life of the yarns analysed (represented by the number of fatigue cycles  $N_n$  and  $N_p$ ), multi regression was utilised, approximating the relationships obtained via linear-square polynomials:

– for smooth cotton yarns:

$$\hat{N}_n = B_0 + B_1 \cdot T_n + B_2 \cdot \sigma_{sn} + B_{11} \cdot T_n^2 + B_{22} \cdot \sigma_{sn}^2 + B_{12} \cdot T_n \cdot \sigma_{sn}, \quad (7)$$

– for the flame cotton yarns:

$$\hat{N}_p = B_0 + B_1 \cdot T_p + B_2 \cdot \sigma_{sp} + B_{11} \cdot T_p^2 + B_{22} \cdot \sigma_{sp}^2 + B_{12} \cdot T_p \cdot \sigma_{sp}, \quad (8)$$

where:

$[B_0; B_1; B_2; B_{11}; B_{22}; B_{12}]^T$  – vector of coefficients of the regression function described by the means of linear-square polynomials.

Values of the unknown coefficient of the regression function were determined by means of the minimal sum of square deviations method using the following relationship:

$$B = (X^T X)^{-1} \cdot X^T \cdot Y, \quad (9)$$

where:

$B$  – vector of coefficients of the regression function,  
 $X$  – matrix of experiments,  
 $X^T$  – transpose matrix,  
 $(X^T X)^{-1}$  – reverse matrix, covariance type,  
 $Y$  – output vector of the object.

Compatibility of an output of the model with that of the object was evaluated based on the coefficient of multi-correlation  $R$ , expressed by means of the following formula:

$$R = \frac{\sqrt{\sum_{i=1}^n (\hat{N}_i - \bar{N})^2}}{\sqrt{\sum_{i=1}^n (N_i - \bar{N})^2}} \quad (10)$$

where:

$N_i$  – output of the object in  $i$ -th experiment,  
 $\hat{N}_i$  – output of the model in  $i$ -th experiment,

$n$  – number of tests within the experiment scheme,

$\bar{N}$  – average value of the output of the object and that of the model, whereas:

$$\bar{N} = \frac{1}{n} \cdot \sum_{i=1}^n N_i = \frac{1}{n} \cdot \sum_{i=1}^n \hat{N}_i \quad (11)$$

The measure of the level of confidence for the model determined is its variance. The more relevant the regression function, the higher the ratio of the variance of the function evaluated to the residual variance. Due to this regularity, in every case the hypothesis of the non-significance of the regression function in the following form was considered:

$$H_0 : \hat{\sigma}_{\hat{N}}^2 \leq \hat{\sigma}_{N-\hat{N}}^2, \quad (12)$$

where:

$\hat{\sigma}_{\hat{N}}^2$  – variance of the regression function,  
 $\hat{\sigma}_{N-\hat{N}}^2$  – residual variance.

Evaluation of the variance of the regression function was performed by means of the relationship:

$$\hat{\sigma}_{\hat{N}}^2 = \frac{1}{n} \cdot \sum_{i=1}^n (\hat{N}_i - \bar{N})^2 \quad (13)$$

whereas evaluation of the residual variance was made via the formula:

$$F_{0,05}(k; n-k-1) = F_{obl} \quad (14)$$

If hypothesis  $H_0$  holds, then the statistics

$$F_{0,05}(k; n-k-1) = F_{obl} = \frac{\hat{\sigma}_{\hat{N}}^2}{\hat{\sigma}_{N-\hat{N}}^2}, \quad (15)$$

have an  $F$  – Snedecor distribution with parameters  $n$  and  $n - k - 1$  i.e. the degree of freedom. Between the statistics  $F$ , and the multi correlation coefficient  $R$ , there is a relationship described via **Equation (5)**.

To obtain a regression equation applicable for controlling the production process of cotton yarns of both types: smooth and flame and that simultaneously fulfils the needs of significance at a particular level (it was assumed  $\alpha = 0.05$ ), the initial condition as described by means of **Equation (6)** should be fulfilled.

Within the analyses performed, we checked whether the regression function considered has a local extremum. For this purpose, we considered the necessary and sufficient conditions for the existence of this extremum. The necessary condition for the existence of a local extremum is the feature that the values of the first partial derivatives are equal to zero. Based on the necessary condition, the following system of equations was obtained:

$$\left. \begin{aligned} \frac{\partial \hat{N}}{\partial T_t} &= B_1 + 2B_{11} \cdot T_t + B_{12} \cdot \sigma_s = 0 \\ \frac{\partial \hat{N}}{\partial \sigma_s} &= B_2 + 2B_{22} \cdot \sigma_s + B_{12} T_t = 0 \end{aligned} \right\} \quad (16)$$

We can rewrite the relationship in the following form:

$$\left. \begin{aligned} \sigma_s &= -\frac{B_1}{2B_{11}} - \frac{B_{12}}{2B_{11}} \cdot T_t \\ T_t &= -\frac{B_2}{2B_{22}} - \frac{B_{12}}{2B_{22}} \cdot \sigma_s \end{aligned} \right\} \quad (17)$$

In the consideration of the necessary condition for the existence of a local extremum, we include a discriminant of two-variable-function in the form of determinant [11]:

$$\Delta = \begin{vmatrix} A & B \\ B & C \end{vmatrix} = AC - B^2, \quad (18)$$

whereas:

$$\begin{aligned} A &= \frac{\partial^2 \hat{N}}{\partial T_t^2} = 2 \cdot B_{11}, \quad B = \frac{\partial^2 \hat{N}}{\partial \sigma_s^2} = 2 \cdot B_{22}, \\ C &= \frac{\partial^2 \hat{N}}{\partial T_t \cdot \partial \sigma_s} = B_{12}. \end{aligned} \quad (19)$$

Based on the sufficient conditions for the existence of a local extremum, in every case the following conditions were analysed:

- a)  $\Delta \leq 0$  – then the regression function analysed does not have a local extremum,
- b)  $\Delta > 0$  and  $A > 0$  – then the regression function analysed has a local minimum,
- c)  $\Delta > 0$  and  $A < 0$  – then the regression function analysed has a local maximum.

In the case of the variable linear masses of smooth cotton yarns  $T_m$  for variable coefficients of the real loading cycle  $\sigma_{sn}$ , the surface of the ultimate fatigue life (represented by the number of loading cycles) can be presented in the co-ordinate system:  $T_m - \sigma_{sn} - N_n$  (**Figure 7**).

In turn, in the case of the variable linear masses of flame cotton yarns [2, 3, 4]  $T_p$ , considering the variable coefficients of the real loading cycle  $\sigma_{sp}$ , the surface of the ultimate fatigue life – represented via the number of fatigue cycles – can be presented in the coordinate system  $T_p - \sigma_{sp} - N_p$  (**Figure 8**).

A mathematical description of these surfaces can be expressed by means of the following functions:  $f(T_m, \sigma_{sn}, N_n)$  and  $f(T_p, \sigma_{sp}, N_p)$ , which internally connect the: linear mass of the yarns, analysed as well as their coefficient of the real load-

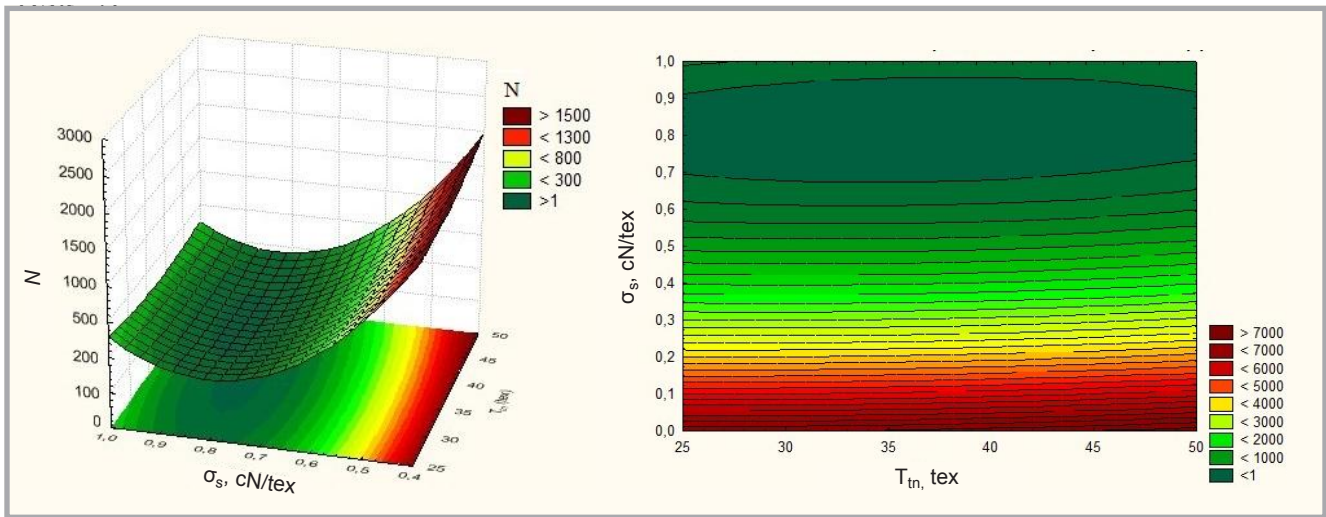

**Figure 7.** Isohyse graphs and surface regression function for the fatigue life of smooth cotton yarn. The regression equation, expressed by means of a linear-square polynomial has the form:  $\hat{N}_n = 7624.371 - 34.440 \cdot T_m - 17741.97 \cdot \sigma_{sn} + 0.705 \cdot T_m^2 + 11352.205 \cdot \sigma_{sn}^2 - 20.779 \cdot T_m \cdot \sigma_{sn}$  coefficient of multi-correlation  $R = 0.921$ ,  $F$ -Snedecor statistics –  $F_{obl} = F_{26}^5 = 29.05 > F_{kr} = 2.59$ .

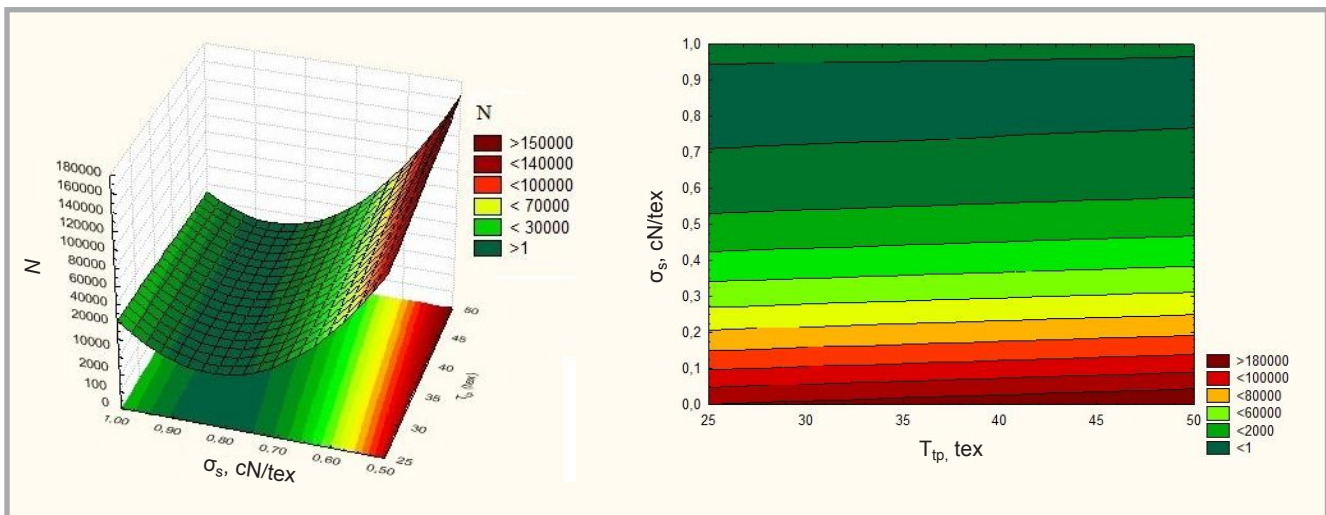

**Figure 7.** Isohyse graphs and surface regression function for the fatigue life of flame cotton yarn. The regression equation, expressed by means of a linear-square polynomial has the form:  $\hat{N}_p = 8.071 \cdot 10^5 + 3848.718 \cdot T_p - 2.126 \cdot 10^6 \cdot \sigma_{sp} - 1.042 \cdot T_p^2 + 1.3507 \cdot 10^6 \cdot \sigma_{sp}^2 - 4219.730 \cdot T_p \cdot \sigma_{sp}$  coefficient of multi-correlation  $R = 0,926$ ,  $F$ -Snedecor statistics –  $F_{obl} = F_{18}^5 = 21.62 > F_{kr} = 2.77$ .

ing cycle and fatigue life (expressed by means of loading cycles). Searching for a surface model based on the results of fatigue investigations is a complex task. The surfaces considered are presented in **Figures 7** and **8**, enclosing information on the mutual relations between the linear masses of smooth cotton yarns  $T_m$  and the values of the coefficients of the real loading cycle (**Figure 7**) as well as between the linear masses of flame cotton yarns  $T_p$  and the values of the coefficients of the real loading cycles.

### Final remarks and conclusions

An analysis of the surface charts (**Figure 7**) of regression function  $\hat{N}_n = f(T_m; \sigma_{sn})$ , shows that the fatigue life of smooth cot-

ton yarns mainly depends on the variations of the values of the real loading cycle. Additionally, it can be stated that the influence of the variability of the linear masses of these yarns is relatively low. It can be observed that the higher values of parameter are in the whole range of parameter  $T_m$ ; analysed; the fatigue strength is lower and lower, going down to the value  $T_m = 0.7814 - 0.00092 \cdot \sigma_{sn}$ , and after crossing this value, it slightly rises (in practice it remains almost constant). The regression function analysed does not have any local extremum.

Analysis of the surface charts (**Figure 8**) of regression function  $\hat{N}_p = f(T_p; \sigma_{sp})$  also indicates that the type of ongoing changes of the fatigue life of flame cot-

ton yarns is similar to adequate changes in the modelling for smooth yarns. In this case, the fatigue life of the yarns considered mainly depends on the changes in values of the real loading cycle, where the influence of changes in the linear masses of these yarns is low. We can observe that the higher the values of parameter are in the whole range of parameter  $T_p$  analysed, the fatigue strength of flame cotton yarns diminishes until the value  $T_p = 0.7870 - 0.00156 \cdot \sigma_{sp}$ , and after crossing this value, it slightly rises (practically remaining the same). The regression function analysed does not have any local extremum.

To sum up, it can be stated that the surface charts presented adequately and



correctly describe the assessment of the results of the simultaneous influence of changes in the linear mass of cotton yarns (smooth and flame)  $T_m$  and  $T_p$ , respectively, as well as of the coefficients of the real loading cycle  $\sigma_{sn}$  and  $\sigma_{sp}$ , respectively, on the fatigue life of the yarns analysed, represented by the number of fatigue cycles  $N_n$  and  $N_p$ .

In engineering practice, an essential condition for the complex assessment of the damage process of a material subjected to time-varying loading is the performance of an analysis of consecutive phases of degradation. In the performance of this task, there is a possibility of utilisation of the surface charts discussed for the choice of parameters necessary for the completion of fatigue analysis of the materials investigated.



## References

1. Drobina R, Machnio M. Evaluation of Properties of Spliced Joints of Ends of Wool Worsted Yarns (in Polish). *Przegląd Włókienniczy* 2000; 54, 10: 3-7.
2. Drobina R, Rysiński J. Fatigue Life Prediction of Knitted Fabrics Made of Cotton Yarns – A Statistical Approach. *FIBRES & TEXTILES in Eastern Europe* 2018; 26, 6(132): 87-94. DOI: 10.5604/01.3001.0012.5176.
3. Drobina R. Assessment of the Fatigue Durability of Standard Smooth and Fancy Flame Cotton Yarns Using a Statistical Model. *FIBRES & TEXTILES in Eastern Europe* 2013; 21, 2(98): 61-67.
4. Frydrych J. HVI Today and Tomorrow in the Light of the Works of the Working Committee of the Committee to Audits Propriety Cotton TTMF, Part. I. *Przegląd Włókienniczy* 1996; 50, (1): 9-11.
5. Grabowska K. Architektura przędzy gładkiej. *Spektrum* 2007; 1: 10-13.
6. Grabowska K. Modelling the Mechanical Properties of Linear Textile Articles about Complex Surfaces. *Exercise books Scientific No. P. 992, Scientific Trials, Vol. 354, Politechnika Łódzka, Łódź, 2007.*
7. Kocańda S, Kocańda A. *Niskocyklowa wytrzymałość zmęczeniowa metali*. Ed. PWN – Warsaw, 1989.
8. Kocańda S, Szala J. *Podstawy obliczeń zmęczeniowych*, ed. PWN – Warsaw, 1997.
9. Konecki W. Influence of the Type of the Tensile Tester on the Strength of Threads (in Polish). *Przegląd Włókienniczy* 1998; 52, 6: 12-13.
10. Krucińska I. Analiza właściwości tworzywa włókien węglowych. *Zeszyty Naukowe Politechniki Łódzkiej, Vol. 643, Rozprawy Naukowe Z. 166*, 1992.
11. Kryński HE. *Matematyka dla ekonomistów*, ed. PWN, Warsaw, 1975.
12. Rysiński J, Drewniak J. Derived Equations for Damage Accumulation in Gearing Wheels Based on Modified Laws of Crack Propagation. *Scientific Journal of Silesian University of Technology. Series Transport*. 2016; 91, 19-31. ISSN: 0209-3324. DOI: 10.20858/sjsutst.2016.91.2.
13. Serwis internetowy Towaroznawstwo: <http://eraumts.com.pl/?przedza,185> (data dostępu: 01.05.2019).
14. Stanisław A. *Przystępny kurs statystyki na przykładach z medycyny z wykorzystaniem programu STATISTICA*, v. II, ed. II, Statsoft, Kraków, 2006.
15. Żurek W. *Struktura liniowych wyrobów włókienniczych*, Wydawnictwa Naukowo-Techniczne, Warszawa 1989, p. 356.

Received 18.07.2019      Reviewed 16.10.2019

RESEARCH NETWORK  
ŁUKASIEWICZ



INSTITUTE OF BIOPOLYMERS  
AND CHEMICAL FIBRES



LABORATORY OF PAPER QUALITY

Since 02.07.1996 the Laboratory has had the accreditation certificate of the Polish Centre for Accreditation No AB 065.

The accreditation includes tests of more than 70 properties and factors carried out for:

- pulps, ■ tissue, paper & board, ■ cores, ■ transport packaging, ■ auxiliary agents, waste, wastewater and process water in the pulp and paper industry.

The Laboratory offers services within the scope of testing the following: raw -materials, intermediate and final paper products, as well as training activities.

#### Properties tested:

- general (dimensions, squareness, grammage, thickness, fibre furnish analysis, etc.),
- chemical (pH, ash content, formaldehyde, metals, kappa number, etc.),
- surface (smoothness, roughness, degree of dusting, sizing and picking of a surface),
- absorption, permeability (air permeability, grease permeability, water absorption, oil absorption) and deformation,
- optical (brightness ISO, whiteness CIE, opacity, colour),
- tensile, bursting, tearing, and bending strength, etc.,
- compression strength of corrugated containers, vertical impact testing by dropping, horizontal impact testing, vibration testing, testing corrugated containers for signs „B” and „UN”.

#### The equipment consists:

- micrometers (thickness), tensile testing machines (Alwetron), Mullens (bursting strength), Elmendorf (tearing resistance), Bekk, Bendtsen, PPS (smoothness/roughness), Gurlay, Bendtsen, Schopper (air permeance), Cobb (water absorptiveness), etc.,
- crush tester (RCT, CMT, CCT, ECT, FCT), SCT, Taber and Lorentzen&Wettre (bending 2-point method) Lorentzen&Wettre (bending 4-point method and stiffness rezonanse method), Scott-Bond (internal bond strength), etc.,
- IGT (printing properties) and L&W Elrepho (optical properties), etc.,
- power-driven press, fall apparatus, incline plane tester, vibration table (specialized equipment for testing strength transport packages),
- atomic absorption spectrometer for the determination of trace element content, pH-meter, spectrophotometer UV-Vis.

#### Contact:

INSTITUTE OF BIOPOLYMERS AND CHEMICAL FIBRES  
ul. M. Skłodowskiej-Curie 19/27, 90-570 Łódź, Poland  
Anita Świętonowska, M. Sc., tel. (+48 42) 638 03 31, e-mail: [elabaranek@ibwch.lodz.pl](mailto:elabaranek@ibwch.lodz.pl)