

S. A. Mirjalili

Textile Engineering Department,  
Yazd University,  
Yazd, Iran  
Tel: +989131519185  
E-mail: amirjalili@yahoo.co.uk

# Using Electromagnetic Force in Weft Insertion of a Loom

## Abstract

*Weft insertion in weaving is an important subject, which has been studied by many research workers, for decades. A number of mechanisms have been invented, designed, manufactured, developed and employed for this purpose, although, only some of these systems have been commercialised. The present paper reports a magnetic weft inserting system, which was designed and manufactured as a model on basis of electromagnetic force. Different features of the system and the parameters affecting in weft insertion are explained and discussed, also.*

**Key words:** *weft insertion mechanism, projectile loom, electromagnetic field and force*

shuttle projection, and all other weaving machines are less efficient. Another similar system which accelerates the projectile is the electromagnetically operated picking motion, in which a current is fed to a solenoid from capacitors having fed from a D.C. source [4]. The projectile used in this system was a permanent magnet, which may lose its magnetic properties and performance after it is used for a while. This may be the main reason why this method was not used as a commercial system the weft insertion. In this work, we describe the designed and built construction of a weft insertion system in which the force required to shoot the projectile is provided by an electromagnetic force. However, the projectile used in our system is the same projectile used in Sulzer-Ruti looms. The system introduced here is significantly cheaper and simpler than the similar existing mechanisms.

## Projectile and electromagnetic force

Generally speaking, there are two methods to throw a projectile using electromagnetic force, stroke and non-stroke. We have selected the second method to shoot the projectile and insert the weft in a weaving machine, as the first method can damage the projectile and may possibly require more parts. Another advantage of the method applied is that it generates less noise as there is no stroke. Furthermore, less energy is wasted in this way.

To launch the projectile in by the non-stroke method, there are three ways, as followings:

**1** – by using a metallic conductive projectile which can change the stroke force according to the equation  $F = L I B$ . In this equation,  $F$  is the electromagnetic force,  $L$  is the length of the solenoid and  $B$  is the magnetic field. However, a major

problem in this method is the necessity of using a direct current (DC) in the projectile during its flight [5].

**2** – by using a projectile built from a permanent magnetic metal, which can be attracted or repelled by the electromagnetic field of a solenoid. However, the projectile loses its magnetic characteristics gradually when used for a while. This property of the projectile can result in some difficulties during weaving, as it attracts tiny iron particles.

**3** – by using a ferromagnetic projectile, which makes it quite suitable for weft insertion in a weaving machine. In this case, the projectile is attracted towards the point with the strongest magnetic field inside the solenoid. If the current still exists in the solenoid, the projectile will stop at the middle of the solenoid after several oscillations. To overcome this problem, the current should be cut when the projectile is in the middle of the solenoid. Therefore, the projectile will continue its motion into the solenoid, due to the attractive force created by the electromagnetic field, in the same direction. In fact this motion would be considered as a launch, because the speed of the projectile is quite high. This can be achieved thanks to the permeability of the electromagnetic field in the ferromagnetic materials, which can promote the magnetic property of the projectile by 2000 times, when it arrives in an external electromagnetic field, generated, for instance, by a solenoid.

It can be claimed that the magnetic field has an important role in generating energy and converting electrical to mechanical energy. It is estimated that about 95% of the mechanical force coming from a magnetic field is in circulating motion and is in linear motion in only a

## Introduction

One of the most important changes made to weaving machines, is has been the invention of shuttleless looms. Different weft insertion systems for weaving machines have been introduced by different companies. However, only some of them have been commercialised. One successful systems of weft insertion is projectiles (missiles), which are so very similar to shuttles, but since they contain no weft yarn pirn, they need require a lower amount of energy compared with shuttle looms. The projectile as yarn carrier is only about one-quarter of the shuttle length and has a mass of one-tenth of the shuttles [1,2]. The required force required to project the projectile is provided by a torsion bar [3]. However, The energy utilisation of the projectile system, is not much more efficient than that of the

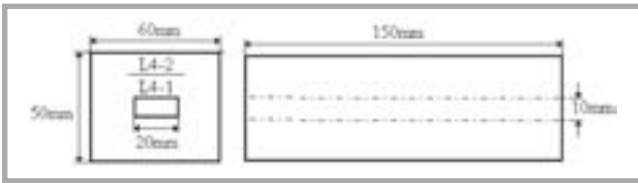

**Figure 1.** The cross section of the solenoid from main and side view.

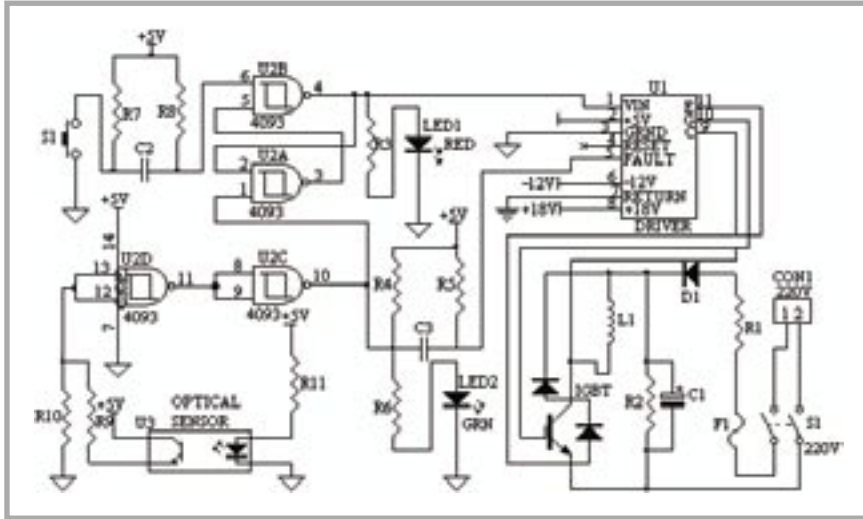

**Figure 2.** The electrical circuit of the switch; L1 - is an inductance parameter of the main coil of the projectile launcher; IGBT - insulated gate bipolar transistor; S1 - main switch of the electrical circuit.

## Design and manufacturing a electromagnetic system of weft insertion

An electromagnetic weft insertion system was designed and built as a laboratory model, which was able to launch the projectile at the speed of 20m/sec. The system consists of electrical and mechanical parts, which are explained below.

### Electrical parts

The electrical parts of the mechanism include a solenoid, optical sensor and a switch to connect and disconnect the current fed to the solenoid. The characteristics of the solenoid used in the pilot system are as following:

- resistance of the coil (R): 1.3Ω
- inductance of the coil excluding the projectile: 1.9mH
- inductance of the coil including the projectile: 4.4mH
- diameter of the solenoid wire: 1mm
- number of coils: 1020
- coil length: 150mm

It should be mentioned that the above data are related to coil with 2 layers, although other solenoid with 4, 6, 8, 10, 12 and 14 layers of coil were built, to study the effect of this parameter on the projectile speed.

Figure 1 shows the main and side view of the solenoid, designed and built in this work, as well as its dimensions.

A different degree of power should be supplied to various parts of the system such as the solenoid and the switches. A circuit was designed and built (Figure 2) which includes an IC of NAND (MC4093), a driver and an IGBT (Insulated Gate Bipolar Transistor) made by Siemens. The output of the circuit when the projectile is not inside the solenoid is zero when the projectile presents in the solenoid, its output is equal to 1. When the projectile is in its position to fly, the output of the sensor is a 12-volts pulse. Pressing the push button causes the

few cases. This may be due to the ease of generating the circular motion from an electrical field. However, if necessary, the linear motion can be created from electromagnetic field.

### Aim of investigation

The aim of our investigation was to design an electromagnetic weft insertion device which could fulfil the demands of modern weaving machines. Additionally, this device should be simple in construction, of relative low manufacturing costs, and reliable in work. The subject of this article is the description and analysis of a part at this device - the electromagnetic launching system which has been designed by us.

The following assumptions were accepted as targets for this research work:

- the maximum acceleration of the projectile, which varies from 7000-11,000 m/s<sup>2</sup> in modern weaving machines should be secured. This quantity can be determined from the stress-strain diagram of the yarn;
- the time during which the projectile has a positive acceleration, which is characteristic for projectile looms should be about 0.007sec.;
- the distance travelled by the projectile, as long as the acceleration is positive, and which determines the space required for the weft insertion system, yarn waste and picking speed, should be around 6-7cm as provided in modern looms;
- the final speed of the projectile at the time of throwing it from the system of weft insertion, which is determined with regard to the loom width, the rpm of the loom and the picking power, should be about 20-25m/sec.

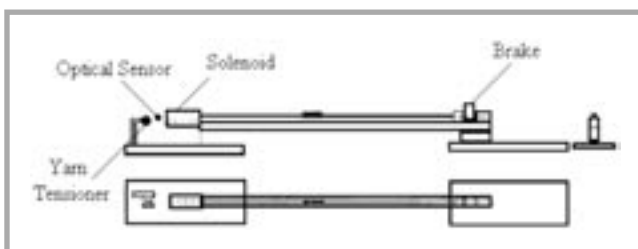

**Figure 3.** The aluminium guide rail of the projectile.

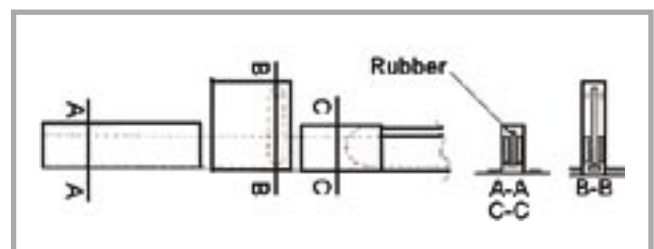

**Figure 4.** The main and side view of the projectile brake.

current to flow in the solenoid and the projectile to be thrown. As the projectile moves in the zone, the relevant sensors control it. Therefore the output of the circuit alters to logic-zero, and consequently the pulse amplified by NAND will be fed to the driver with an input voltage of  $V_{in}$ . At the output of the driver, there is a pulse with the state of 1, which causes the IGBT to act, i.e. the current of the circuit will be cut. To protect the solenoid against the high current, a driver is used, which cuts the current to IGBT when it exceeds 150A.

### Mechanical parts

These parts include an aluminium rail and a simple brake. The aluminium rail guides the projectile and keeps it in a straight track when flying. The brake consists of a rubber, placed inside a metallic U-shaped slot, which should stop the projectile without any vibration or damage. Figure 3 and Figure 4 show the main views of these parts respectively.

As can be observed from Figure 3, the optical sensor is placed at a distance of 30 mm from solenoid.

### Experimental and discussions

As mentioned earlier, different parameters of the system were studied and investigated. These parameters, which affecting the projectile speed, consist of the distance of the projectile from the solenoid, the capacitor voltage, the coil number of layers and the projectile length. The role of these parameters on the projectile speed are investigated and discussed here.

#### Distance of the projectile from the solenoid

The most important factor affecting the speed of the projectile, is the distance of the projectile from the centre of the solenoid. The shape of the current-time, fed to the solenoid has a vital influence on the magnetic field and subsequently on the magnetic force. The square shape is more desirable, although practically this curve is as shown in Figure 5.

The amount of the current when cut is important because the current, after reaching its maximum (current peak), should drop as quickly as possible. This period has been marked as the Turn-Off Time on the figure. As the position of the projectile before generating the electro-

**Figure 5.** Variations of the current (fed to solenoid) vs. time in msec..

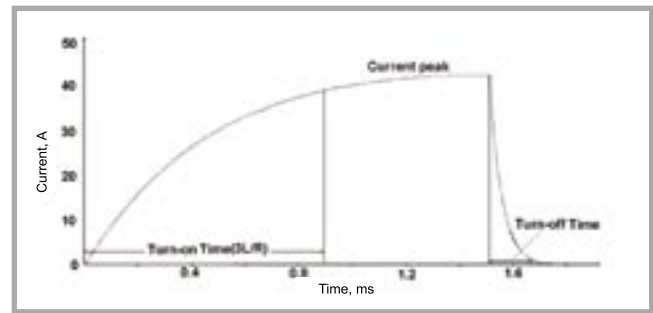

magnetic field influences the speed of the projectile, it was decided to measure and study this parameter also. The measurement was made for different positions from the centre of the solenoid, and the results are illustrated in Figure 6.

#### Capacitor voltage and energy analysis

Another parameter which affects the projectile speed is the voltage fed to the capacitor. Its amount can be calculated from equation (1):

$$V = RI + \frac{L \partial I}{\partial t} + \frac{\partial L}{\partial t} I \quad (1)$$

The equation for the energy can be accordingly obtained from equation (2):

$$\int_0^t VI dt = \int_0^t RI^2 dt + \int_0^t L \frac{\partial I}{\partial t} I dt + \int_0^t L \frac{\partial I}{\partial t} I dt + \int_0^t \frac{\partial L}{\partial t} I^2 \Rightarrow W = W_R + W_I + W_L \quad (2)$$

where:

- $W$  - the total consumed energy,
- $W_R$  - the energy dissipated by heat generating, in ohm,
- $W_I$  - the delivered energy relevant to the increase of the current, and
- $W_L$  - the delivered energy related to the variation of the inductance (resistance) of the solenoid.

Therefore the equation (2) can be rewritten as equation (3):

$$W - W_R = W_I + W_L = fL + 1/2 mv^2 \quad (3)$$

where  $f$  is the force resulting from friction and air resistance,  $m$  is the mass of the projectile,  $L$  is the length of the projectile, in the electromagnetic field created by the solenoid, and  $v$  is the speed of the projectile.

According to equation (3), when  $W - W_R$  increases the projectile speed would increase if  $fL$  is assumed to be constant. When designing the system,  $W_R$  should be reduced as much as possible, so that

the speed of the projectile and the efficiency of the system increases.

The minimum required voltage for the coil for the system to properly works properly is 10 volts. At higher voltages, 10-30 volts, the speed of the projectile quickly increases as can be seen from Figure 7.

As can be seen from this figure, the speed of the projectile at medium voltages (30-60 volts) does not increase significantly. The increase of the voltage beyond 60 causes the speed of the projectile to decrease. Therefore when adjusting the voltage, it is recommended that this quantity be set at within the range of 20-30 volts. Since at this range the energy consumption is less compared with the range of 30-40volts, the speed of the projectile does not considerably decrease. In other words, the condition of this range is optimum, particularly at higher voltages.

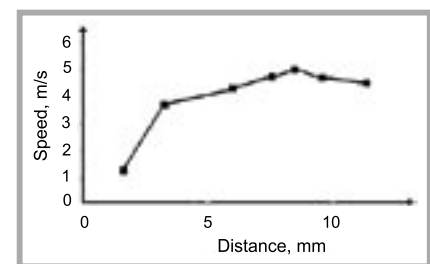

**Figure 6.** Speed variations of the projectile vs. its distance from the centre of the solenoid.

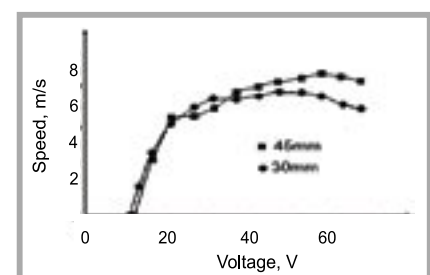

**Figure 7.** The speed variation of the projectiles (30 and 45mm long) vs. voltage.

From this figure, it is also observed that the longer projectile has a higher speed.

In another investigation, the amount of the energy required to shoot the projectile at the same speed of the projectile used in Sulzer-Ruti looms was measured. It was observed that it needs significantly less energy (electrical energy) in comparison with those machines. The required energy for this purpose in the existing weaving machines is about 3%.

### The number of layers in the coil

To study the effect of the layer number of the solenoid (coil), several coils with different numbers of layers were prepared.

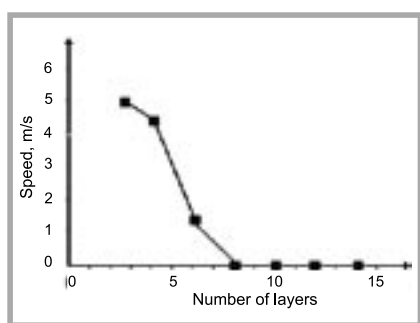

Figure 8. The speed variation of the projectiles vs. the number of coil layers.

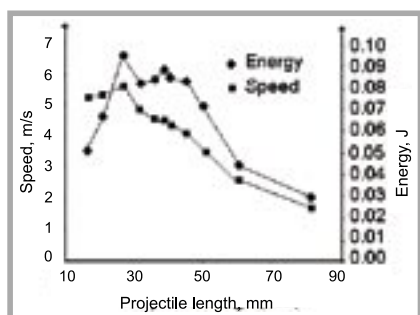

Figure 9. Average speed and kinetic energy variations of the projectiles vs. its length.

Table 1. The speed variations and its relevant energy consumption for different projectile lengths.

Projectile length, mm	Projectile speed, m/s	Kinetic energy, J
15.0	5.20	0.050
20.0	5.30	0.067
25.0	5.70	0.096
30.0	4.80	0.082
35.0	4.60	0.084
37.5	4.50	0.088
40.0	4.30	0.085
45.0	4.05	0.083
50.0	3.50	0.073
60.0	2.60	0.045
80.0	1.75	0.030

Next, the speed of the projectile was measured for each case, separately. The results have been given as illustrated in Figure 8.

It should be noted that the voltage used in these measurements was 23 volts. Figure 8 suggests that the best results will be obtained when there are 2 layers in the solenoid's coil. When the number of layers increases both the inductance (L) and the time constant ( $3L/R$ ) will increase. When this period increases, the current fed to the solenoid cannot attain its maximum quickly and consequently the speed of projectile will not increase. This happens as the magnetic field falls when the current cannot reach its maximum due to the increase of the time constant. This is because of the residual inductance in the solenoid, which keeps the projectile in the middle of the solenoid, despite switching off the current. But at the lower inductance, the magnetic field remains in the solenoid for a short time and the projectile continues moving.

### Projectile length

The shorter projectiles, when are subjected to equal force from the electromagnetic field, should be logically be accelerated more, compared with longer projectiles, for which only their smaller length is inside the electromagnetic field. The effect of this parameter on the speed and kinetic energy of the projectiles was studied by measuring the speed of the projectiles with different lengths within a range of 15-80mm. In order to measure the speed of the projectile, a speedometer consisting of an optical sensor was used. The optical sensor records the initial and final times when the head and tail of the projectile passes in front of it. As the length of the projectile is known, the velocity of the projectile at the moment of the launch can be calculated. We also measured the mass of the projectile and calculated the kinetic energy of the projectiles separately. The results are given in Table 1 and shown in Figure 9.

### Summary and conclusions

Considering the results obtained from the experimental work, we can draw the following conclusions:

- The current of the solenoid should be kept at the maximum.
- The material used for the solenoid sheath should be in the form of sin-

tered powder, and the material should have high magnetic permeability, with a linear B-H curve and high specific electrical resistance.

- The rate of opening and closing the circuit should be kept at the maximum.
- As piezoelectric sensors are fairly expensive, infrared sensors are recommended, because of their high speed, small size, good performance (as it is not affected by the electromagnetic field) and low prices.
- The constant time of the circuit ( $L/R$ ) should be the minimum.
- The speed of the projectile will increase with the increase of the number of coils in the solenoid, and not the number of layers in the coils.
- The projectile length should be at a range of 75%-125% of the solenoid length.
- The increase of the voltage causes the speed of the projectile to increase but its efficiency to decrease.

The system designed and constructed by us worked satisfying, although does not fulfilled all assumptions listed in the chapter 'Aim of investigation', as can be clearly seen from the dependencies presented in this paper. Especially the speed of 20-30 m/s was not achieved. On the basis of the results obtained we can state that the way accepted by us to solve the problem of using electromagnetic force in weft insertion was chosen correctly, but further research work must be carried out to improve the parameters obtained.

### Acknowledgment

The author would like to express his special thanks to The Ministry of Industries and Mines of the Islamic Republic of Iran, for its financial and moral supports in accomplishing this research work.

### References:

1. O. Talavasek and V. Svaty, *Shuttleless weaving machines*, Elsevier Scientific Publishing Company, Oxford, 1981.
2. J. J. Vincent, *Shuttleless looms*, The Textile Inst., 1980.
3. A. Ormerod, and W.S. Sondhelm, *Weaving, Technology and operations*, The Textile Inst., 1995.
4. *Czechoslovak patent No. 93,970*.
5. *Haber-Schaim, Dodge and Walter, PSSC Physics, Fifth Edition*, Heath, Toronto, 1981.

Received 12.03.2004 Reviewed 09.03.2005